

Checking procedure for overvoltage damage.

Overvoltage can be caused by following reasons: high voltage surge, lightning, electrostatics etc.

You can check if routerboard was damaged by overvoltage or not, by using following testing method:
All measurements should be made while power is turned off!

1. Check voltage drop between diode array pin#1 and Ground.
 You should measure in diode mode (hold “positive” wire on the Ground and “COM” wire on the diode array pin#1).
 Diode array pin#1 is always marked by dot mark on the diode array case (see picture 1 in the appendix).
 Diode array reference number and voltage drop values could be found in the table 1;
2. Check termination resistors resistance in RJ-45 connector. For this measurement you should take patch cord and plug it into the routerboard (see picture 2 in the appendix), and after that measure resistance of termination resistors.
 Resistance value between Rx and Tx line must be **150 Ohm +/-4%**.
 If resistance value is smaller or higher then Tx/Rx line was damaged by high voltage surge.
 Ethernet connector reference number of each routerboard you can find in the table 1.

Table 1

Routerboard type	Diode array reference number (voltage drop value, V)	Ethernet connector reference number
192	D2-D4; D17-D19; D21-D23 (0,25V-0,32V)	J6-J8; J13-J18
411, 411AH, 411AR, 411U, 411UR, 411UAHR	D601 (0,39V-0,49V)	J601
433, 433AH, 433UAH	D601, D602, D603 (0,40V-0,50V)	J601, J602, J603
433L, 433UAHL	D505, D503, D501 (0,30V – 0,40V)	J503, J502, J501
433G, 433GL	D510, D512, D509, D508, D503, D502 (0,3V-0,4V)	J502, J501
411L, 411UHAL	D5 (0,45V - 0,55V)	J5
411GL	D501, D504 (0,32V - 0,40V)	---
450	D601-D605 (0,30V-0,50V)	J601-J605
450G	D501-D510 (0,21V-0,3V)	J501-J503; J505

493, 493A	D601 (0,30V-0,40V) D701, D703, D705, D707, D709, D711, D713, D715 (0,38V-0,44V)	J601, J701-J708
493G, 493GAH	D601, D603, D605, D607, D609, D611, D614, D615, D618, D620, D801, D803, D805, D807, D809, D811, D815, D820 (0,21V-0,3V)	J601-J603; J605; J801-J803, J805
711	D400 or D401 (it should be 6 pin device) (0,31V-0,4V)	Check ethernet port (J4 or J400)
711G 711GA	D100, D101 (0,26V-0,32V)	---
750, 750UP	Check voltage drop between test points and Ground (see picture 3 in the appendix). This value should be in the range from 0,28V to 0,35V	Check each Ethernet port in the Ethernet connector J401
750G	Check voltage drop between test points and Ground (see picture 3 in the appendix). It should be in the range from 0,21V to 0,28V	
750GL, 751G, 951G	Check voltage drop between transformer TRF100 pins and Ground (see picture 3 in the appendix). It should be in the range from 0,32V to 0,4V Check voltage drop between transformer TRF101 pins and Ground (see picture 3 in the appendix). It should be in the range from 0,4V to 0,5V	
951-2n	Check voltage drop between test points and Ground (see picture 3 in the appendix). This voltage drop value should be in the range from 0,30V to 0,40V	
751U-2HnD	D405, D409, D404, D408, D403 (0,26V – 0,33V)	J401
1000	D18-D25 (0,34V-0,4V)	J6-J9
Groove	D1001 (0,31V-0,4V)	J1000
SXT-5HnD, SXT-5HPnD	D1001 (for old board version) D100 (for new board version) (0,30V – 0,5V)	J1000 (for old board version) J400 (for new board version)
SXT G-5HnD	D100, D101 (0,40V – 0,50V)	-----

SXT Lite2, SXT Lite5, SXT2nDr2, SXT5nDr2	Check voltage drop between test points and Ground (see picture 5 in the appendix). This voltage drop value should be in the range from 0,32V to 0,40V	J400
OmniTIK U-5HnD	D7, D8, D11, D13, D14 (0,28V-0,34V)	Check 2-5 ethernet ports
1200	D505, D506, D503, D501, (0,28V – 0,4V) D603, D601, D702, D701, D704, D703, (0,26V – 0,4V) D801, D803, D817, D818, D813, D814, D809, D810. (0,20V – 0,4V)	Check each ethernet port (J8702, J8703, J8704, J8705, J8701, J702, J701, J601, J602, J501.)
250GS	Check voltage drop between test points and Ground (see picture 3 in the appendix). This voltage drop value should be in the range from 0,21V to 0,28V	
435G	D501-D504; D507, D508 (0,21V-0,3V)	J501, J502
600	D401, D402, D701-DD704 (0,32V-0,4V)	J401, J702;
800	D1, D3, D5, D8, D9, D11 (0,26V-0,38V)	J11, J13
1100, 1100AH, 1100AHx2	see picture 4 in the appendix	
2011	D115, D105 (0,4V-0,5V) D116, D106, D117, D107, D118, D108, D119, D109 (0,32V - 0,4V) D129, D128, D125, D124, D123 (0,30V – 0,4V)	Check each Ethernet port in the Ethernet connector J101
Metal 5SHPn	D1001 (0,32V-0,42V)	J1000
Cloud Core Router (CCR1036, CCR1016)	D603, D602 (0,40-0,50) D115, D117, D111, D113, D105, D107, D101, D103, D905, D907, D901, D903, D805, D807, D801, D803, D705, D707, D701, D703, D605, D607. (0,32-0,40V)	J112, J111, J102, J101, J902, J901, J802, J801, J702, J701, J602

911, 912;	Check voltage drop between test points and Ground (see picture 6 in the appendix). This value should be in the range from 0,40V to 0,50V	-----
------------------	--	-------

APPENDIX

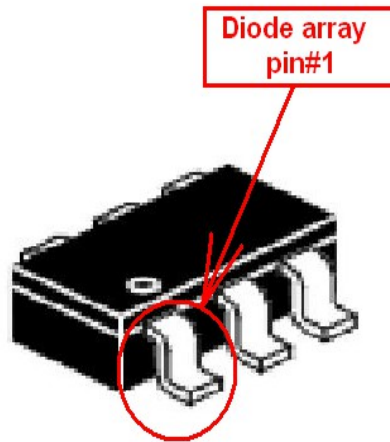

Picture 1

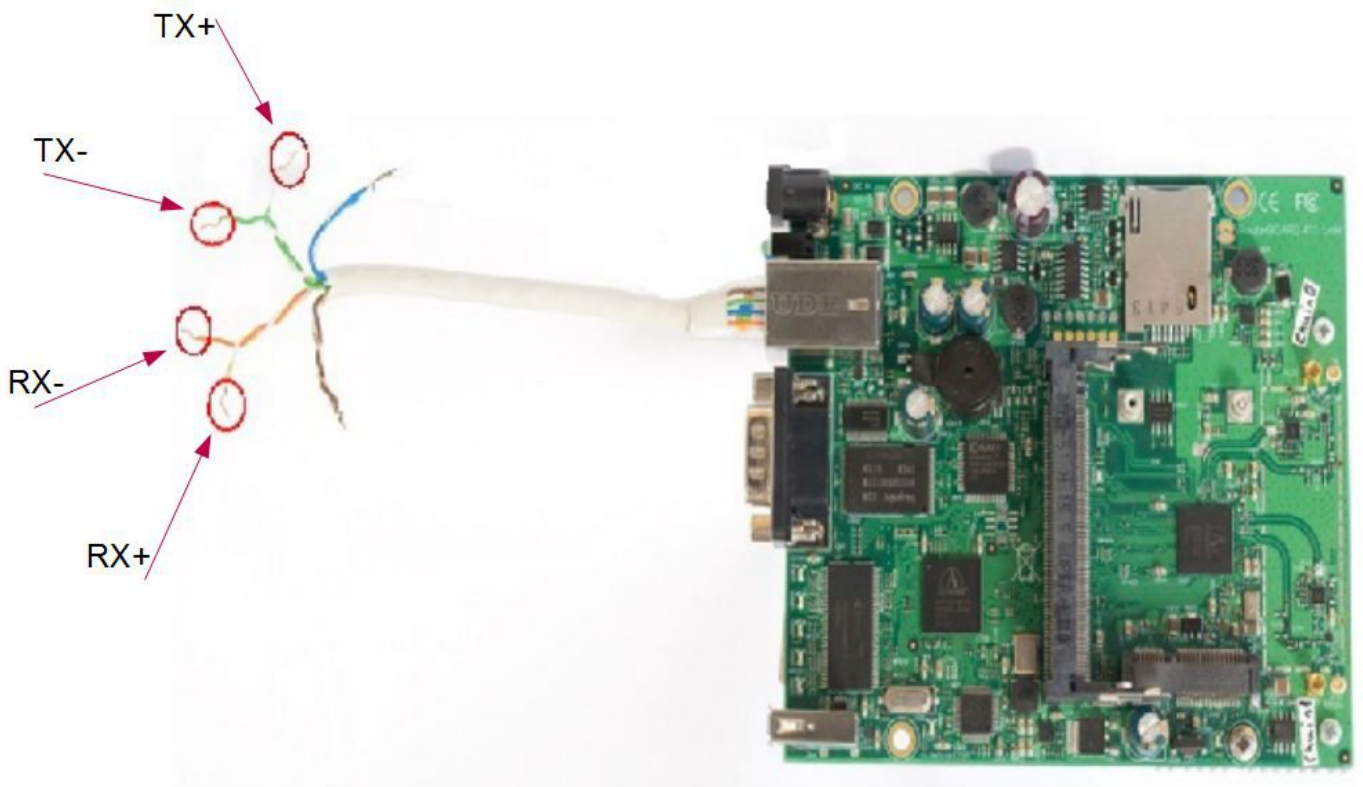

Picture 2

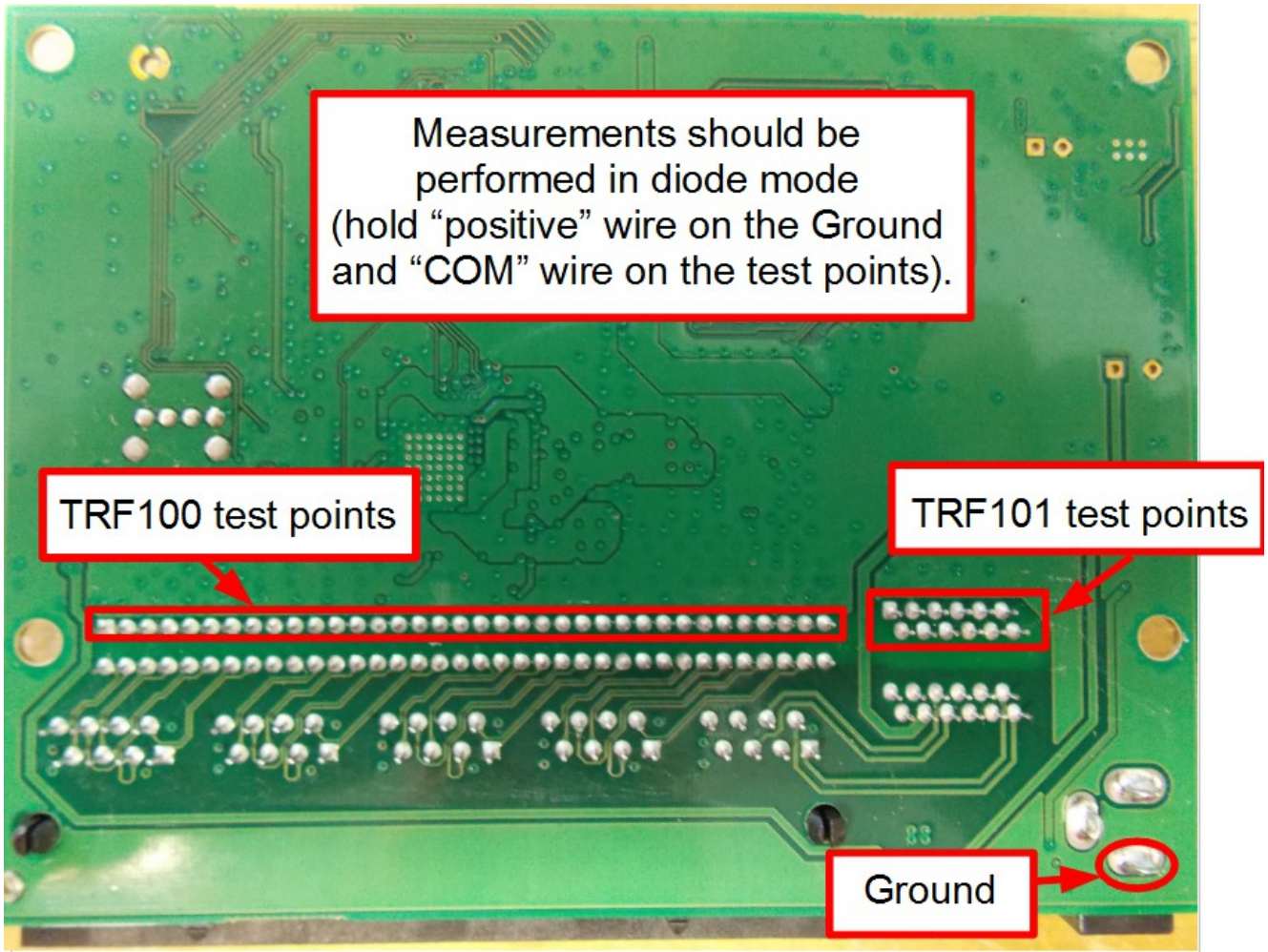

Picture 3

Check termination resistors resistance in RJ-45 connectors.

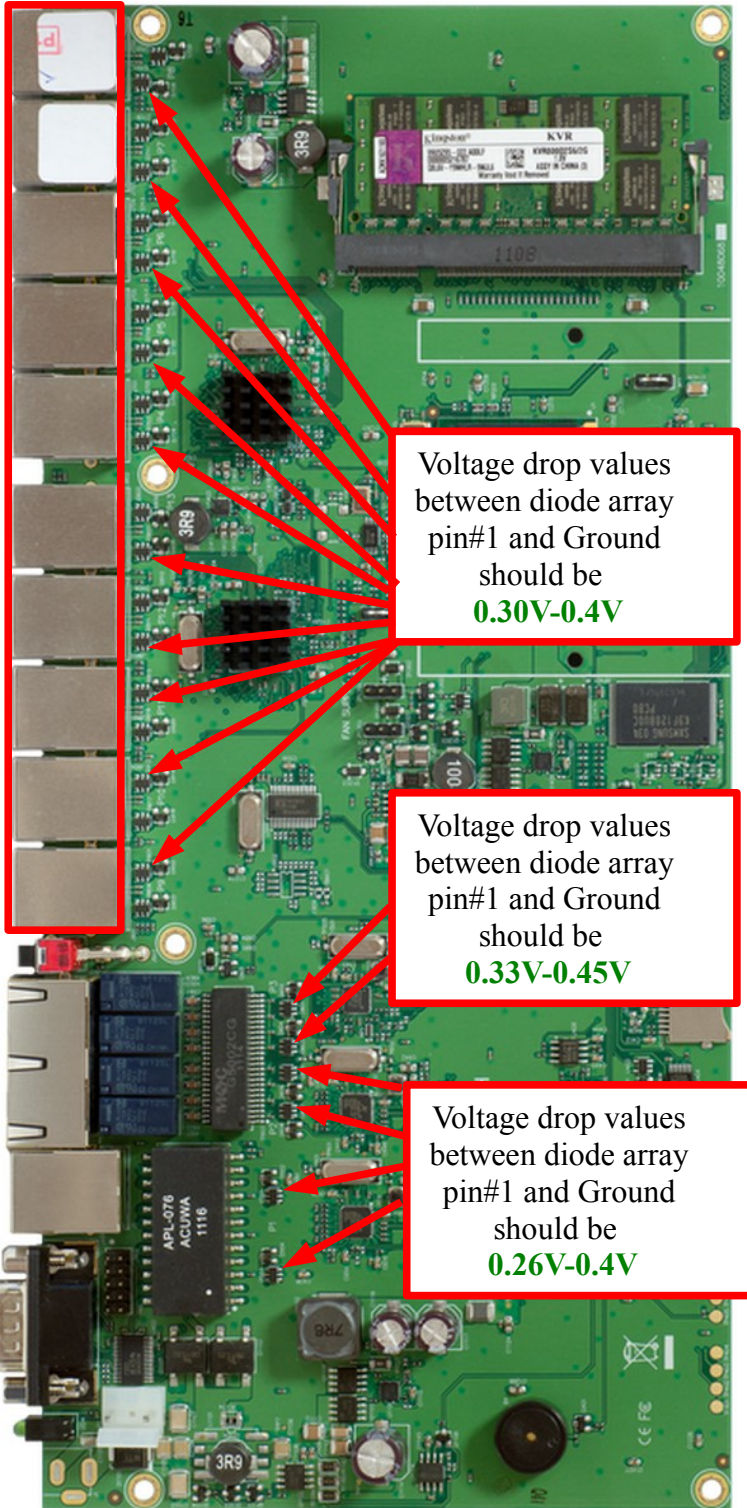
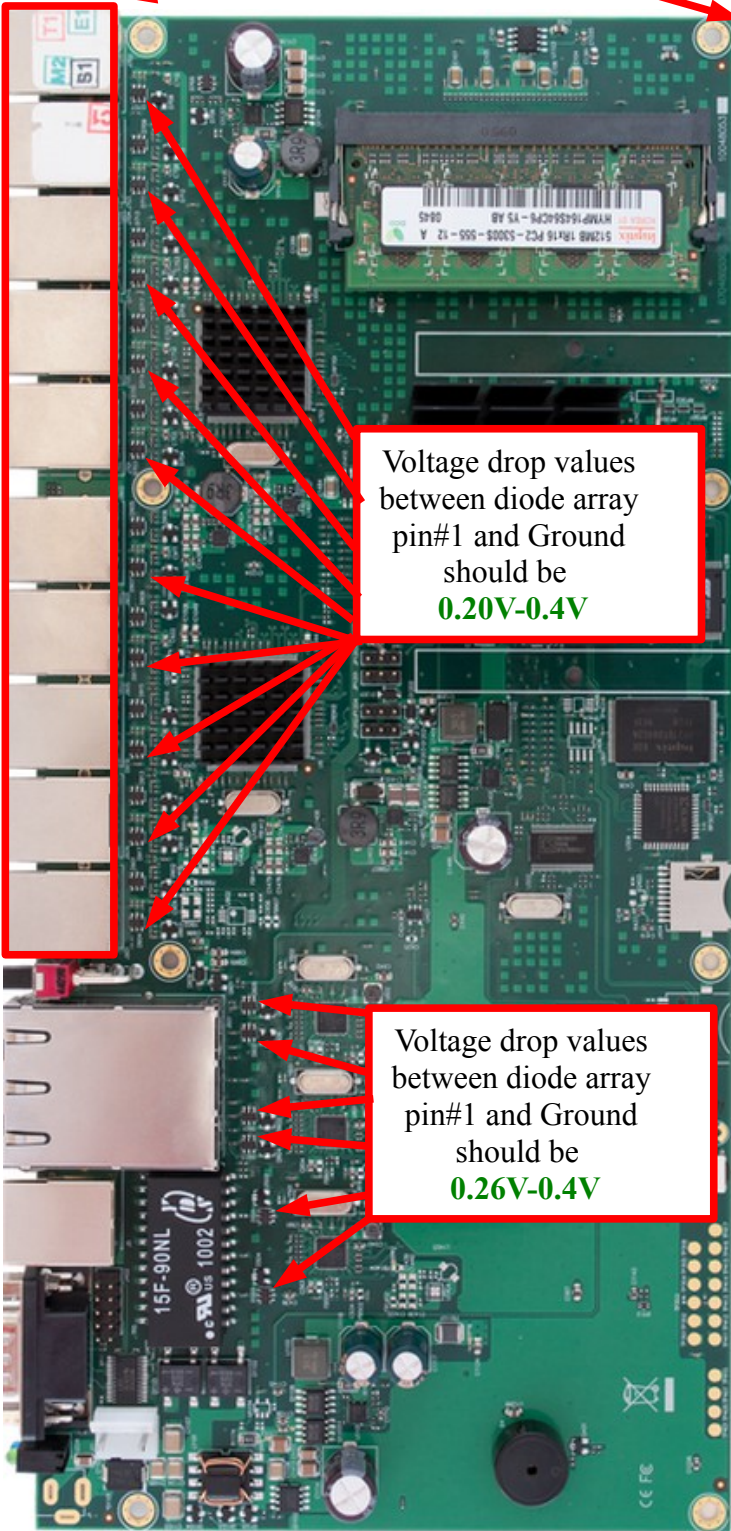

Picture 4

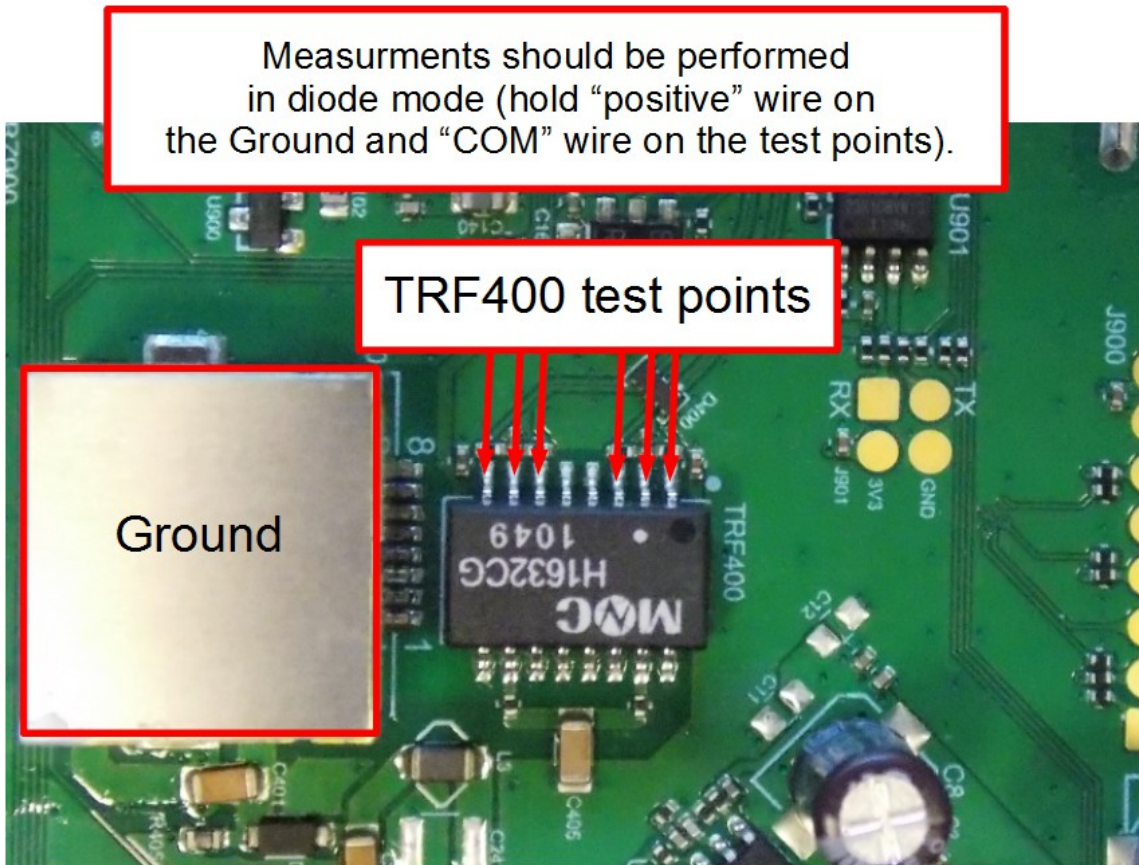

Picture 5

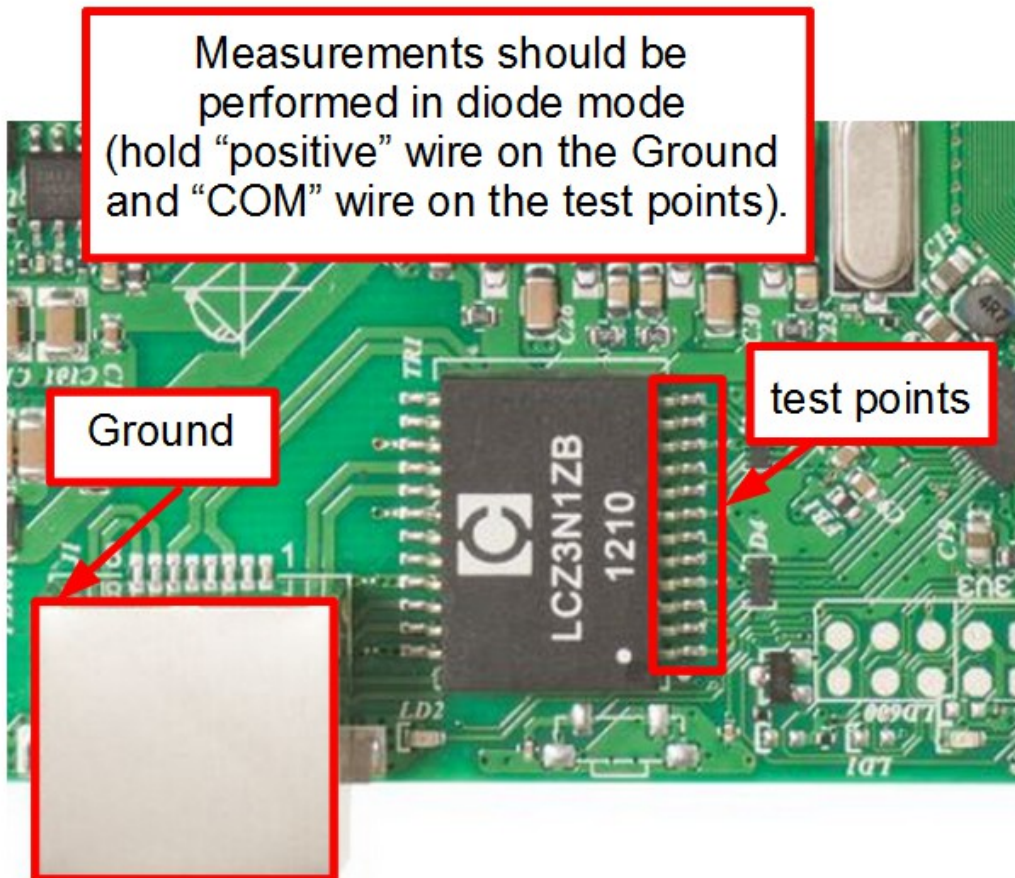

Picture 6